

Air & Gas Pressure Switches



DBL

DESCRIPTION

Adjustable vacuum, pressure, and differential pressure switches for air and other non-combustible, non-aggressive gases.

APPLICATION

Air pressure control and monitoring of ducts, filters, fans and other devices in ventilation and air conditioning systems.

FEATURES

- Compact & easy to install
- Adjustable switching differential
- High accuracy & life cycles
- Calibrated, scaled setpoint knob



SPECIFICATIONS

Type of operation	On/Off, single-stage, micro switch
Output	1 SPDT, 250 VAC, 1.0 (0.4) A
Trip/setpoint	Internal linearly scaled knob
Switching differential	Screw adjustable
Sensing techniques	2 pressure chambers separated by diaphragm
Diaphragm material	Silicone
Life cycles	1,000,000
Permissible ambient temperature	
- Working/Storage	-4°F to 185°F (-20°C to 85°C)
Wire	
- Connection	Spade
- Size	Maximum 16 AWG (1.5 mm ²)
Cable entry	1/2" NPT conduit connection
Housing	
- Material	Base = PA 6.6 – Cover = Polystyrene
- Color	Transparent
- Protection	NEMA 3 (IP 54)
- Dimensions	Diameter 4.0 x 2.3 in. (100 x 58 mm)
Installation	Surface mounted
Pressure port connection	
- Diameter	2 for PVC tube, P1 (+) and P2 (-) 0.236" (6 mm) for O.D. 3/16" (8 mm) push-on tubing
Ship weight	0.4 lb (0.2 kg)

certified ISO 9001



"Setpoint can be adjusted without field gauge reading"



Adj. Setpoint Range* Inch WC (Pa)	Adj. Switching Diff.** Inch WC (Pa)	Max. Operation Pressure Inch WC (kPa)	Scale Type	Part Number
0.08 to 0.8 (20 to 200)	0.04* to 0.08 (10 to 20)	40 (10)	930.80	DBL-205L
0.16 to 0.4 (40 to 100)	0.08* to 0.16 (20 to 40)	40 (10)	930.81	DBL-205
0.16 to 0.8 (40 to 200)	0.08* to 0.16 (20 to 40)	40 (10)	930.82	DBL-205A
0.20 to 2.0 (50 to 500)	0.08* to 0.16 (20 to 40)	40 (10)	930.83	DBL-205B
0.80 to 4.0 (200 to 1000)	0.40* to 0.80 (100 to 200)	40 (10)	930.85	DBL-205D
2.0 to 10.0 (500 to 2500)	0.60* to 1.20 (150 to 300)	40 (10)	930.86	DBL-205E
Kit: (2) Pitots, (2) Grommets, 6.5ft. (2.0 m) Tubing				DBZ-06

* The adjustable trip/setpoint within the control range is calibrated for vertical mounting position pressure, port connection pointing downwards. If mounted in horizontal position, deduct 0.08 inch WC (20 Pa) from desired setpoint for off-set adjustment. If setpoint at the bottom of range, do not mount DBL in horizontal position.

** Factory set switching differential is ± 15% of trip/setpoint.

WIRING DIAGRAM

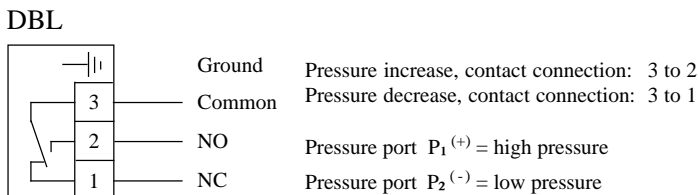

DBL PRESSURE SWITCH INSTALLATION

DBL-Install

Mounting position

Mounting the switch in the vertical position, with the pressure port connection pointing downwards (figure 1).

If mounted in horizontal position, deduct 0.08 inch WC (20 Pa) from desired setpoint for offset adjustment. If the setpoint is at the bottom of the range, do not mount the pressure switch in the horizontal position. Never install the switch where the setpoint knob faces downward. This will cause incorrect switch performance.

Surface mounting

Mount with four screws through bracket (figure 2). Do not tighten the screws excessively. It could deform the pressure switch and lead to air leakage.

Duct air pick-up

To insure good airflow to the pressure switch, it is suggested to use the tubing and pitot kit DBZ-06 (figure 3).

Pressure port connections

Pressure port P1 (+) = high pressure, it is located on the lower part of the housing base. Pressure port P2 (-) = low pressure, it is located on the upper part of the housing base (figure 4).

Electrical connection and switching function

Electrical wiring connections must be done per local building and electrical codes. The DBL data sheet will provide all appropriate data for the control relay and output switching.

Control settings

Do not adjust the setpoint knob or screw adjustment for the switching differential (figure 5) when high voltage power is connected to the pressure switch. For setpoint setup and switching differential data, refer to DBL data sheet.

Housing cover installation

Mount housing cover (figure 6) prior to operating the pressure switch.

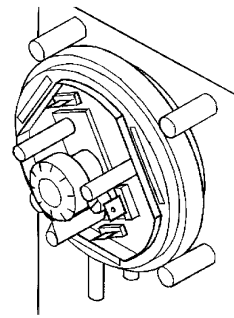
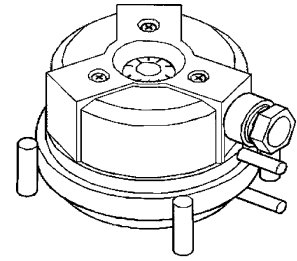

Figure 1

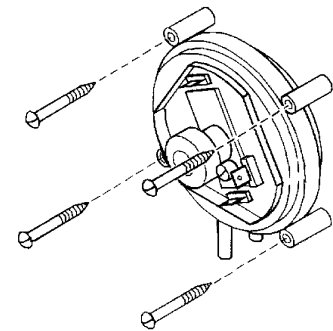

Figure 2

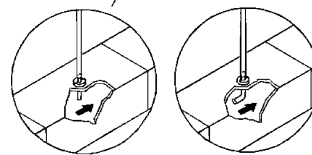
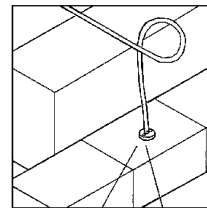

Figure 3

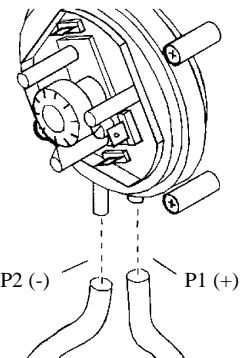

Figure 4

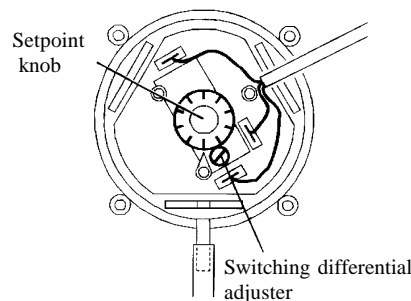

Figure 5

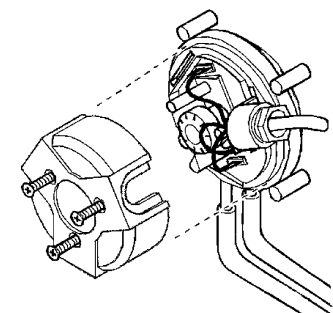

Figure 6